



Sonoma 1216 Pergola

Manual and Installation Instructions



Please read these instructions before removing parts from crate

Introduction

Thank you for your purchase from The Outdoor GreatRoom Company. This pergola has been engineered and manufactured in the USA. This user manual will help make the installation and setup of your new pergola fast and easy. Outdoor GreatRoom company recommends visiting with your local authority for building codes, restrictions, or requirements for this product. Please read the manual through before starting the project.

This pergola is made of premium grade kiln dried Douglas Fir. Douglas Fir, if maintained properly, will last a very long time, similar to life of both Cedar and Redwood. All finished pieces have been stained via submersion to ensure even penetration. It is recommended that the pergola receive a clear, oil-based stain yearly to maintain the color, minimize warping and prevent rotting. Every few years a colored oil based stain should be used to keep the original color.

Important:

- **Anchoring Required—Contact your local authority for details**
- **Read instructions prior to assembly**
- **Assistance is required and we recommend at least 2 people for installation**
- **Do not let wood pergolas sit on bare ground. Over time this can cause moisture damage and rotting of wood.**
- **If you have questions contact the place of purchase**

Douglas Fir Lumber may have surface splits. This occurs while the lumber dries and seasons. This characteristic is also known as “checking” in the lumber industry. These can be upwards of 1/8” running inches to feet in length. These characteristics do not affect the structural strength and integrity of the product nor does it affect or void the warranty.

Before Beginning, make sure that all components listed on the next page were included with your hardware kit. Contact your dealer if any parts are missing.

Tools Required

- Corded or Cordless Drill
- Measuring Tape
- Level
- Metric Socket Set
- Rubber Mallet
- Step Ladder
- Hammer Drill*
- Concrete Drill Bit*
- Concrete Anchors*
- Construction grade adhesive (such as PL 400)

*Only Required for anchoring to concrete surfaces.











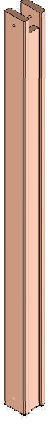
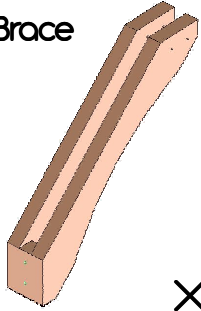
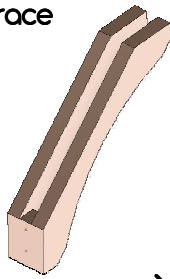

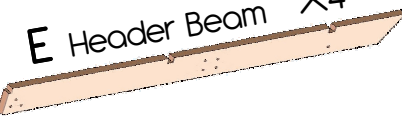
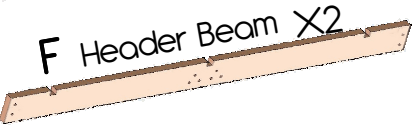
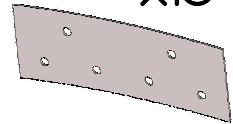
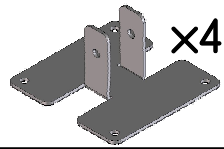
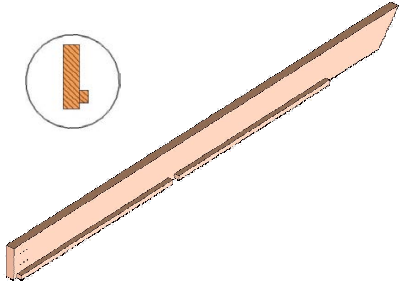

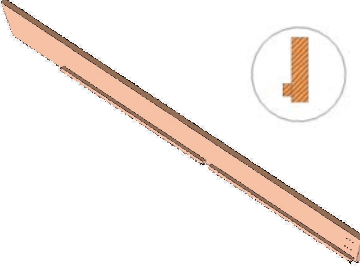
NOTE

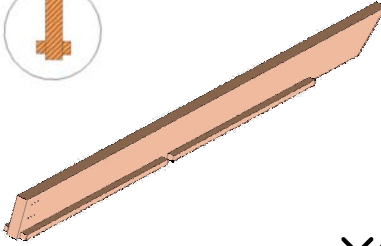
Extreme weather including heat, cold, rain, snow and high humidity affect all wood products. Taking proper care of your pergola is essential to ensure long-lasting performance and beauty.

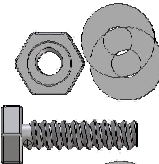
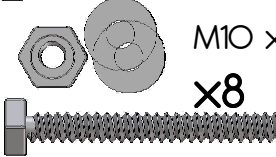
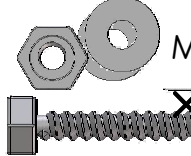
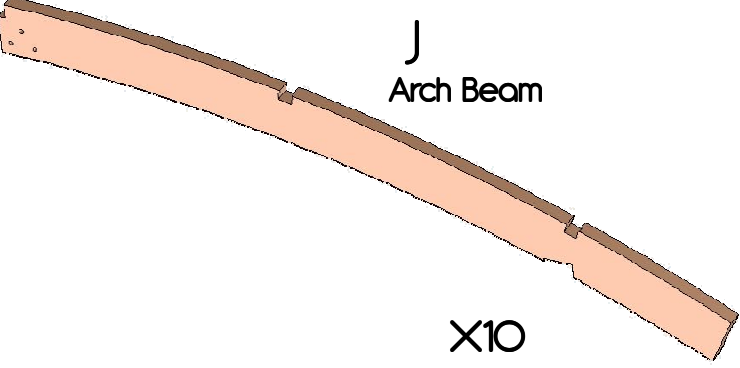
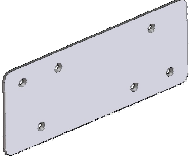
Disclaimer—The Outdoor GreatRoom Company is not liable for damage caused by weather or misuse

Included Parts:

| | | | | |
|--|--|---|---|--|
| <p>A</p>  <p>Column</p> <p>X4</p> | <p>B</p>  <p>Tall Corbel Post Brace</p> <p>X4</p> | <p>C</p>  <p>Short Corbel Post Brace</p> <p>X4</p> | <p>D Header Beam X4</p>  <p>E Header Beam X4</p>  <p>F Header Beam X2</p>  | <p>Arch Mending plate x10</p>  <p>L</p> <p>Foot x4</p>  <p>M</p> |
| <p>G</p>  <p>Canopy Beam, Right L</p>  <p>X2</p> | <p>H</p>  <p>Canopy Beam, Left L</p>  <p>X2</p> | <p>I</p>  <p>Canopy Beam, T</p>  <p>X6</p> | <p>ALL bolts require washers</p> <p>M10x 55 Hex Bolt (with nut and washers) x30</p>  <p>N</p> <p>M10 x160 Hex Bolt (with nut and washers) x8</p>  <p>O</p> <p>M10 x 90 Hex Bolt (with nut and washer) x28</p>  <p>P</p> | |
| <p>J</p>  <p>Arch Beam</p> <p>X10</p> | | | <p>K</p>  <p>Rectangular Mending Plate X10</p> | <p>1.25" Wood screw Q x60</p>  <p>3" Wood screw R x120</p>  <p>2" Wood screw S x8</p>  |

Step 1:

Bolt steel footplate to each of four supplied posts "A" as shown. Use hardware "M", and "O".

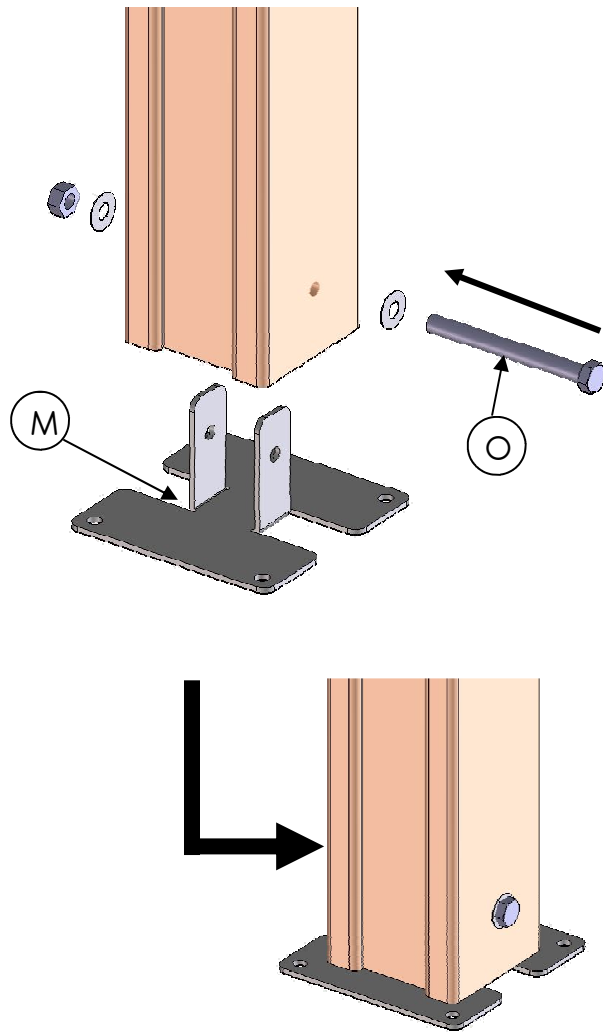

Step 2:

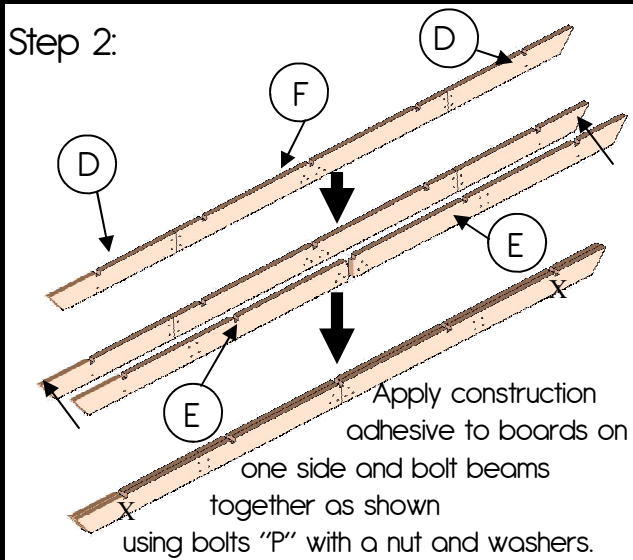

Apply construction adhesive to boards on one side and bolt beams together as shown using bolts "P" with a nut and washers. Bolt heads should be on the side comprised of beams "E" (Do not use bolts in holes marked with an X above.) Repeat for opposite side ledger beam. Insert 2" wood screws "S" into pre-drilled holes near ends of beams "D" once bolts are in place and tightened.

Step 3:

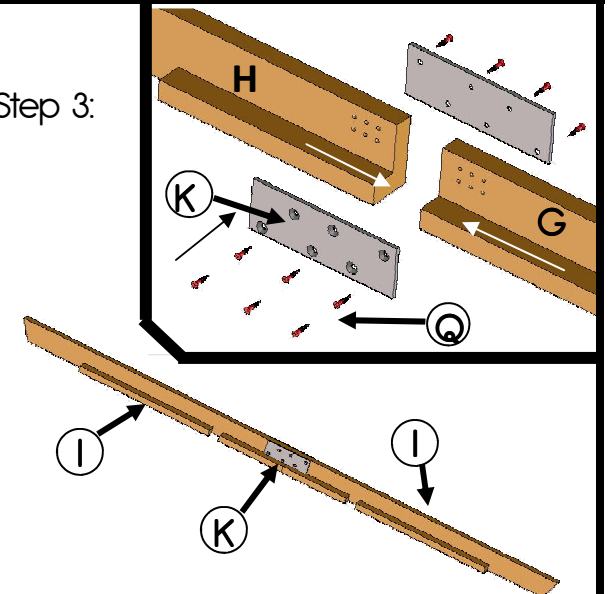

Attach rectangular mending plates "I" to canopy beams as shown. Attach beams "G" to beams "H" [x2], and beams "I" to "I" [x3]

Step 4:

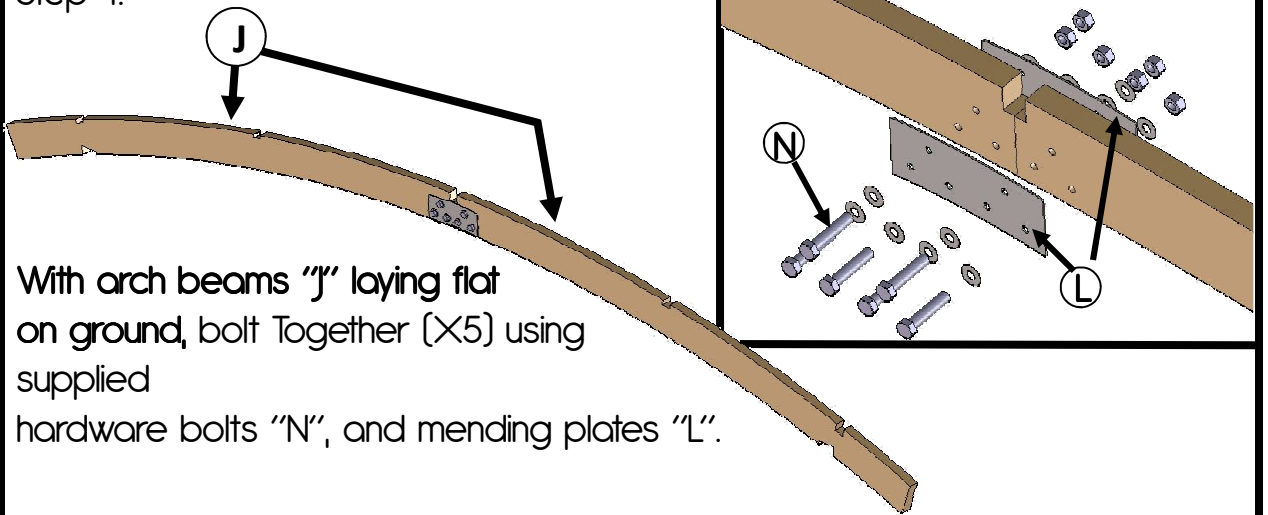

With arch beams "j" laying flat on ground, bolt Together (x5) using supplied hardware bolts "N", and mending plates "L".

NOTE: In the remaining steps, a rubber mallet may be useful in fitting beams together properly.

Step 5:

Lay columns on level surface. Bolt ledger beams assembled in step 2 to columns "A" with beams "E" facing upward.

Hardware "O" is used. Repeat step 5 for remaining posts.

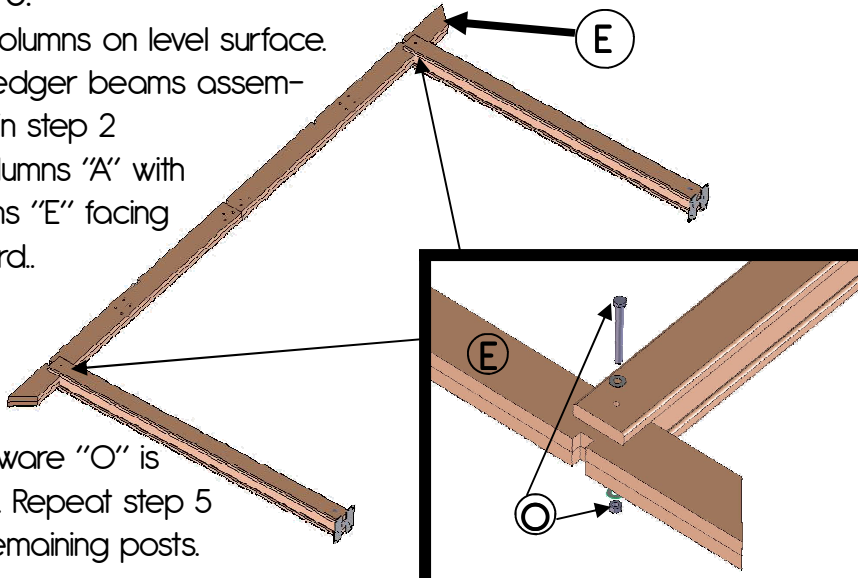

Step 7:

Once header beams are installed and bolts are tightened, end arched beam sections can be installed between them and secured in place with hardware screws "R". Position components with bolt heads visible from the outside of pergola.

After end arched beams are installed, Tall Corbel Post Braces "B" can be attached as shown below with hardware screws "R" (Upper 3 screws are installed from both sides of corbel). Once corbels are in place, install remaining arched beams with screws "R"

Insert 2 screws "R" into each side of column. Ensure columns are squared with ledger beam before fastening. Repeat for all columns.

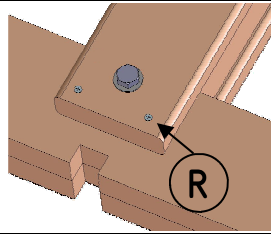

Step 6:

Attach short corbels "C" with hardware screws "R" (upper screws should be installed from both sides of ledger beam)

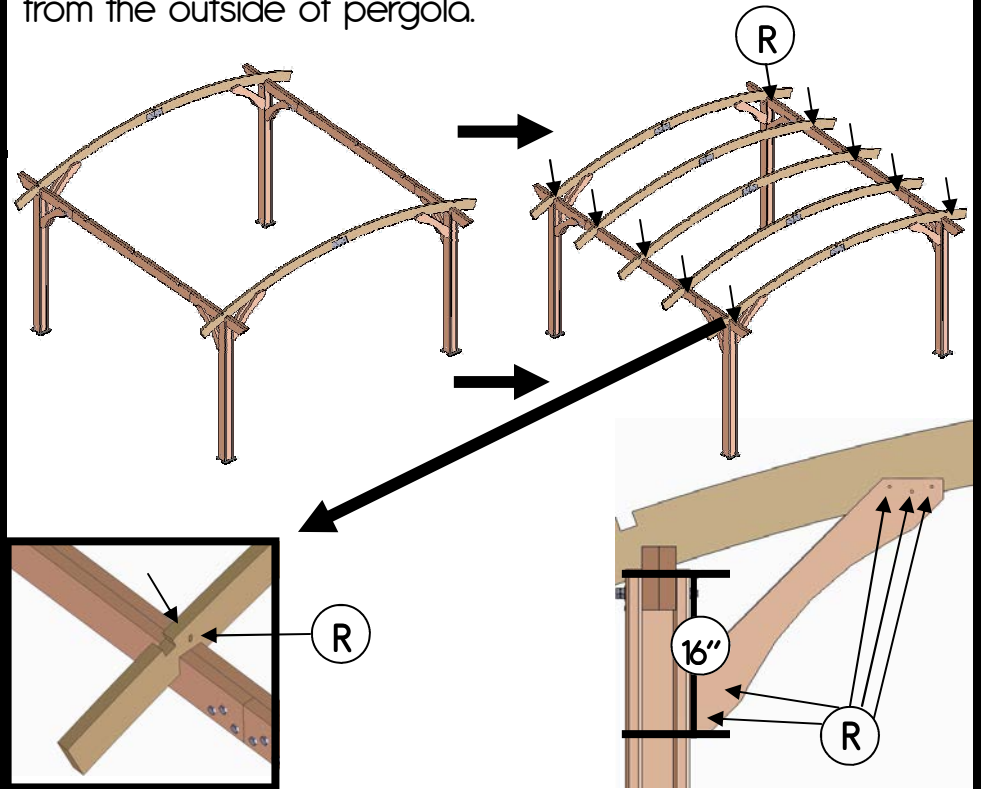
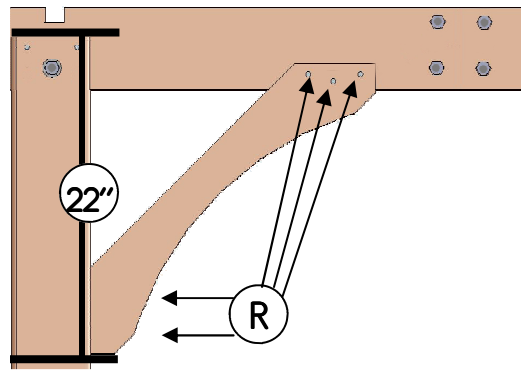

Step 8:

Carefully position posts in final location. Check for square. Install canopy beam assemblies with screw "R" at intersections with arch beams. The use of a level or similar tool is highly suggested.

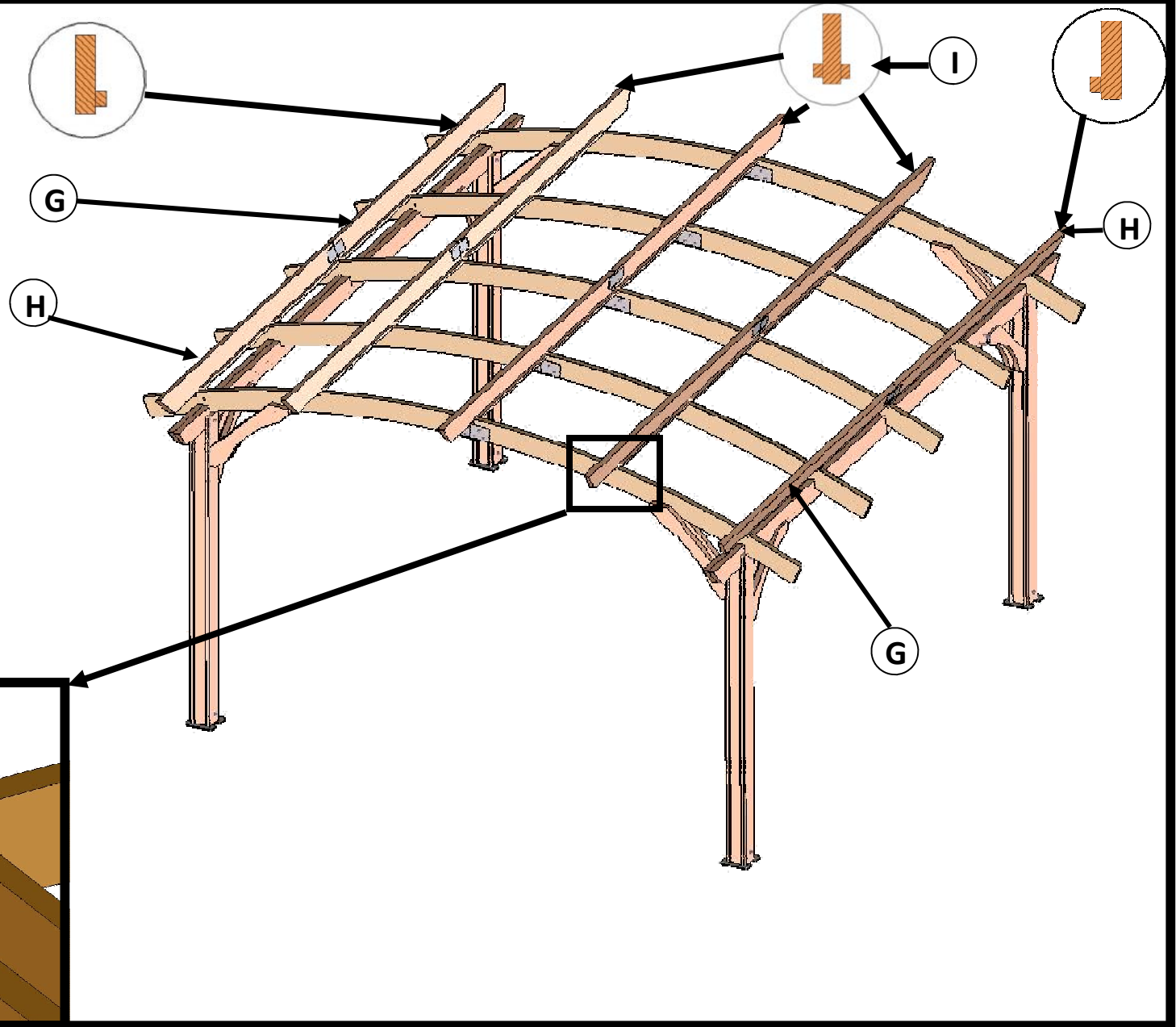

Dimensional and Post Location Information

NOTE 1:

Recommended 12-18" DIA footing (12" minimum). Check local codes for depth minimums. Footing typically 24" minimum depth, 42" for extreme cold climates.

NOTE 2:

Do not do final tightening of all bolts until unit is fully assembled, level and square. After Pergola is **IN POSITION, SQUARED UP, & LEVELED**, anchor posts with masonry bolts through steel footplates.

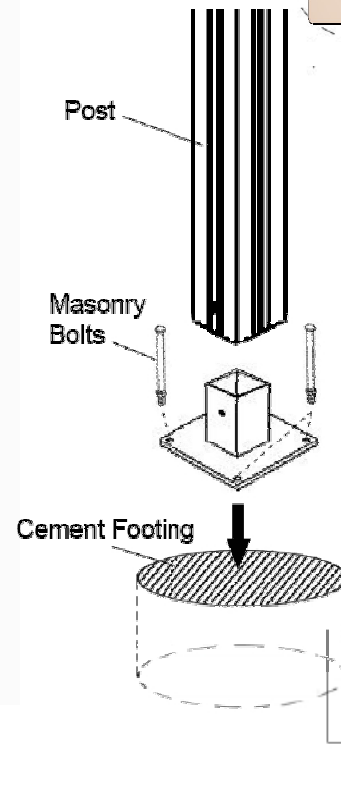
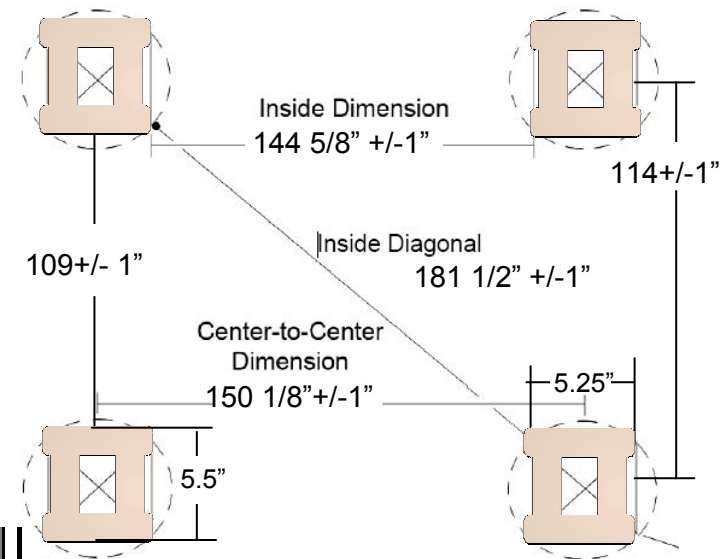
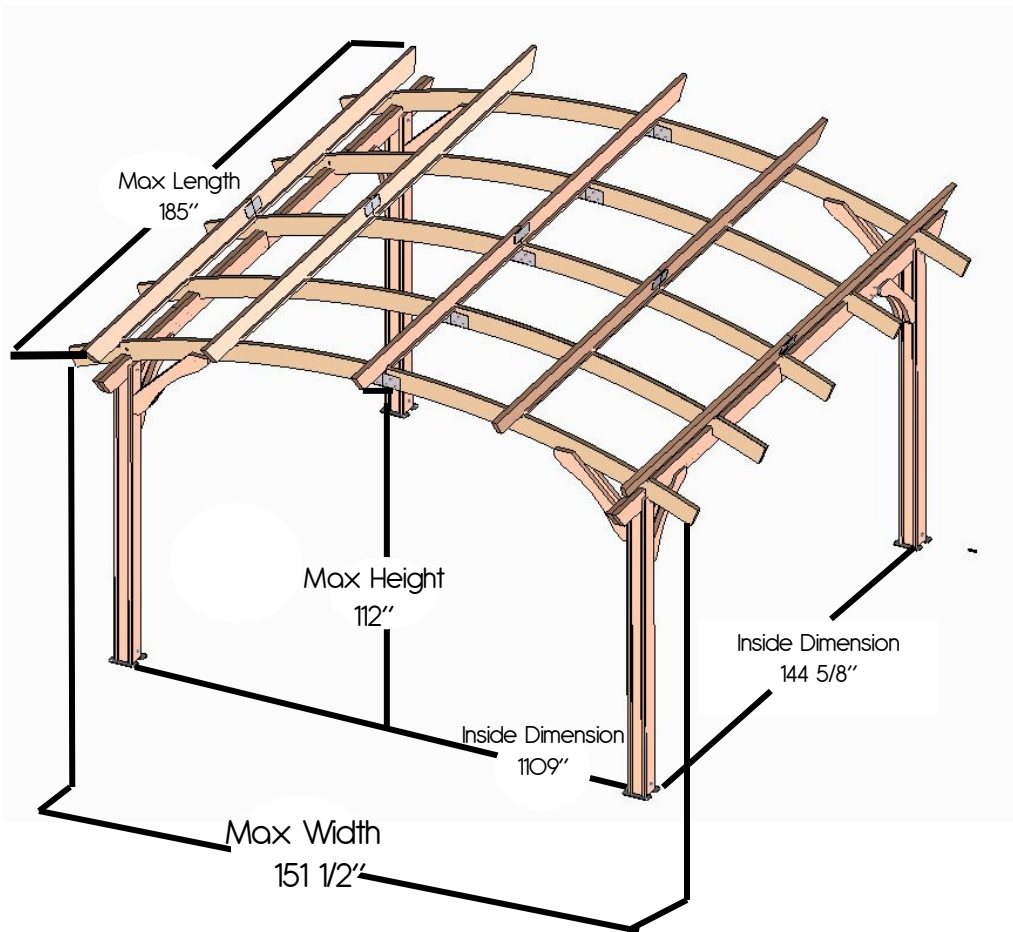

14" Overhang (all sides)

(Suggested for installation on lawns. For other surfaces, appropriate mounting methods should be used)

Depth of Masonry Footing Varies by Local Code & Conditions



Sonoma Pergola Warranty Information

Your new Sonoma 1216 pergola is warranted against structural defects for a period of three (3) years from the date of purchase. This does not apply to damage caused by excessive loads such as snow or use of roof as storage. Your Sonoma pergola is warranted against defects in finish and other defects not related to structure for a period of one (1) year from the date of purchase. All metal hardware must be sprayed with a clear lacquer sealer once your pergola is assembled to prevent rust and corrosion.

The Outdoor GreatRoom Company extends the following warranty for Outdoor GreatRoom outdoor products used in the United States of America or Canada. Dealers and employees of The Outdoor GreatRoom Company have no authority to make any warranty or authorize any remedies in addition to or inconsistent with the terms of this warranty. This warranty gives you specific legal rights. You may also have other rights that vary from state to state.

The Outdoor GreatRoom Company warrants that this Outdoor GreatRoom Outdoor Product (the "Product") will be free from defects in material and workmanship for a period of one (1) year for finish and other non-structural defects and three (3) years from its date of purchase structurally. This warranty is subject to the conditions, exclusions and limitations described below.

This warranty applies only to the original owner of the Product and is non-transferable. The Outdoor GreatRoom Company obligation under this warranty does not extend to damages resulting from (1) assembly, operation or maintenance of the Product not in accordance with the Installation/Assembly Instructions, Operating Instructions and the Listing Agency Identification Label furnished with the Product; (2) installation or use which does not comply with local building codes and ordinances; (3) shipping, improper handling, improper operation, abuse, misuse, accident or unworkmanlike repairs; (4) Installation or use of components not supplied with the Product or any other components not expressly authorized and approved in writing by The Outdoor GreatRoom Company; and/or (5) modification of the Product not expressly authorized and approved in writing by The Outdoor GreatRoom Company. Any of the circumstances described in the previous sentence voids this warranty. This warranty is void if the Product or any component has been removed, repaired, or replaced before The Outdoor GreatRoom Company has been afforded a reasonable opportunity to inspect the Product.

This warranty is limited to the replacement or repair of defective components or workmanship and The Outdoor GreatRoom Company may fully discharge its obligations under this warranty by repairing or replacing, at its discretion, the defective components. The Outdoor GreatRoom Company will provide replacement parts at no charge and will pay reasonable and necessary labor and freight costs related to replacing or repairing defective components under this warranty. The maximum amount recoverable under this warranty is limited to the purchase price of the Product and, if The Outdoor GreatRoom Company is unable to provide replacement or repair in an expedient and cost-effective manner, The Outdoor GreatRoom Company may discharge all obligations under this warranty by refunding the purchase price of the Product.

EXCEPT TO THE EXTENT PROVIDED BY LAW, THE OUTDOOR GREATROOM COMPANY MAKES NO EXPRESS WARRANTIES OTHER THAN THE WARRANTY EXPRESSED HEREIN. THE DURATION OF ANY IMPLIED WARRANTY IS LIMITED TO THE DURATION OF THE WARRANTY SPECIFIED ABOVE. IN NO EVENT SHALL THE OUTDOOR GREATROOM COMPANY BE LIABLE FOR ANY INCIDENTAL OR CONSEQUENTIAL DAMAGES CAUSED BY DEFECTS IN THE PRODUCT. Some states do not allow limitations on how long an implied warranty lasts, or do not allow exclusion or limitation of incidental or consequential damages, so these limitations may not apply to you.

To obtain service under this warranty, you must:

Send written notice of the claimed condition to: The Outdoor GreatRoom Company, 2015 Silver Bell Road, #195, Eagan, MN 55122.

Affirm that you are the original owner of the Product.

Provide The Outdoor GreatRoom Company reasonable opportunity to investigate the claim, including reasonable opportunity to inspect the Product prior to any repair or replacement work and before the Product or any component of the Product has been removed.

Obtain The Outdoor GreatRoom Company's consent to any warranty work before the work is done.