

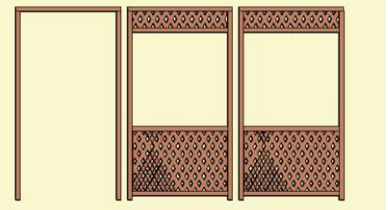

800-403-9259 (Toll Free)

Assembly instructions for:
**BACKYARD
GAZEBOS**

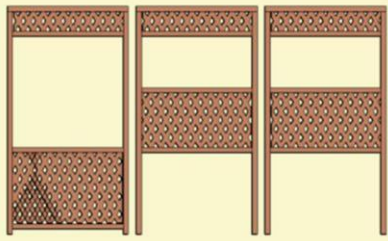
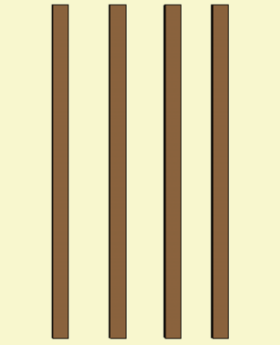
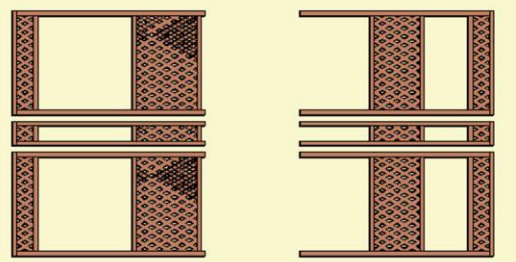
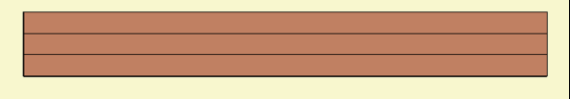
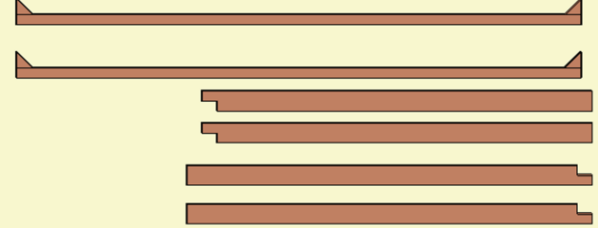

Quantity	Description	Drawing
3	Front wall panels – door and window panels	
3	Rear wall window panels	
4	Wall Posts	
6	Left side & right side walls	
1	Bar tabletop	
6	Roof timbers	

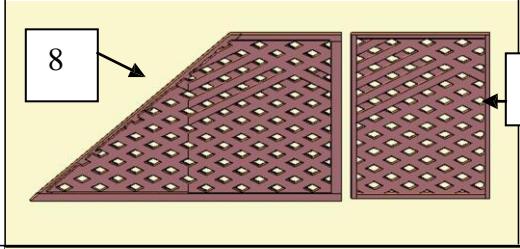
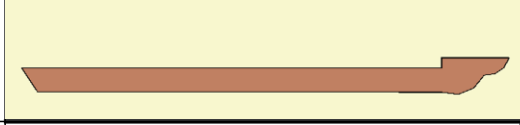
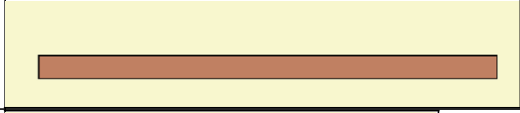
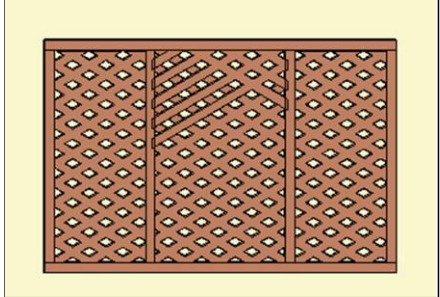
10	Roof panel		
10	Rafters		
10	Rafter cover		
1	Rooftop panel		

Quantity	Description
6	Bolts 4" x 5/16", washers & nuts
10	Bolts 6 1/2" x 3/8", washers & nuts
4	Bolts 3 1/2" x 5/16", washers & nuts
8	Bolts 4 1/2" x 5/16", washers & nuts
4	Bolts 8" x 3/8", washers & nuts
130	Screws 3"x 8" SS

ASSEMBLY INSTRUCTIONS

The parts that go together have the same numbers written next to the predrilled holes they attach to. Align the parts with the numbers as shown for ease of reference.

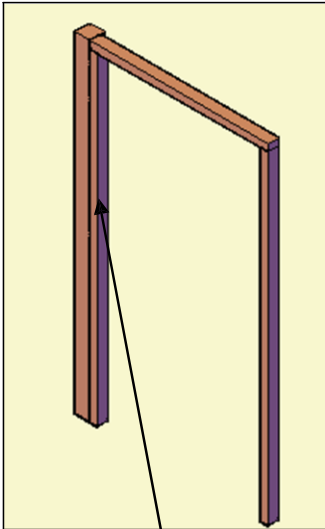

Step 1:

ASSEMBLE WALLS: Attach front wall door frame section to post with six deck screws (3"X 8"). (Match up the numbers to attach the two parts together).

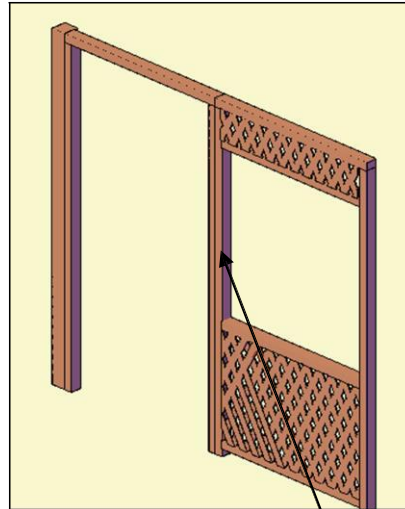

Step 2:

Attach front wall door frame panel to front wall window panel with six deck screws (3"X 8"). (Match up the numbers to attach the two parts together). And repeat the steps 1 & 2 in all walls & the post

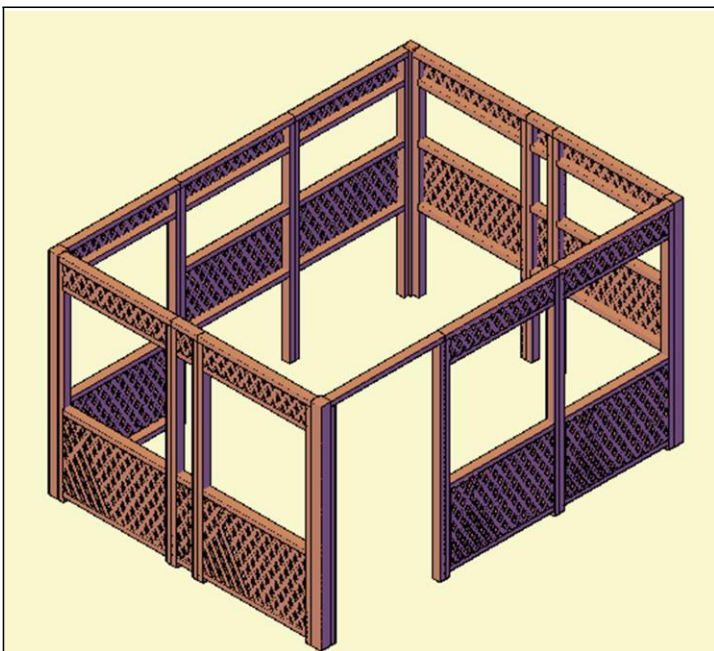

When you finish, the walls of the Gazebo should be as shown.

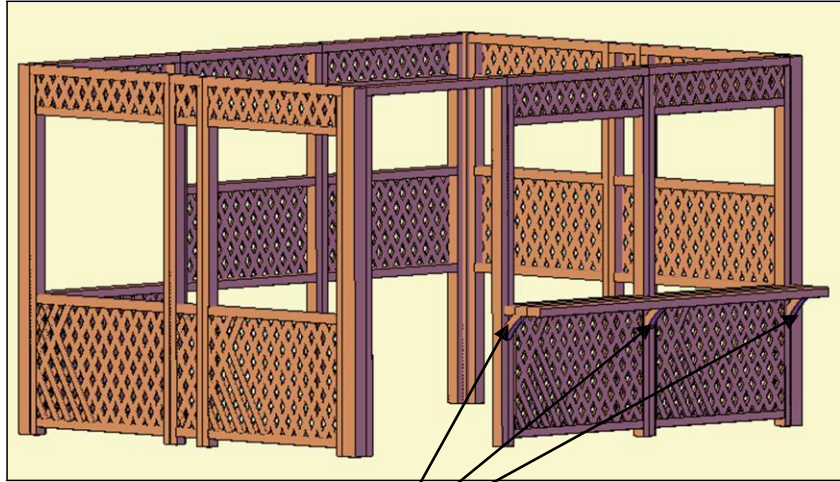

Step 3:
 Attach bar tabletop to front wall with six deckscrews (3"X 8"). (Match up the numbers to attach the two parts together).

Step 4:
 Attach the roof timbers with 4 bolts (3 1/2"x 5/16"), washers & nuts as shown. (Match up the numbers to attach the two parts together). Tap the bolt all the way into the wood to set it. Then add a washer and nut and lightly tighten.

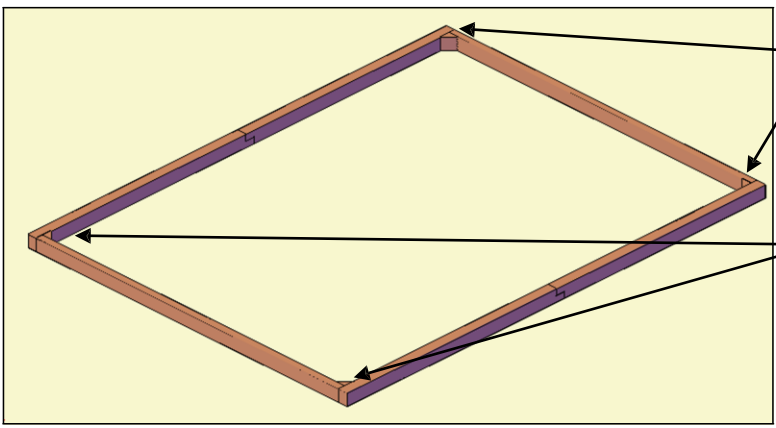
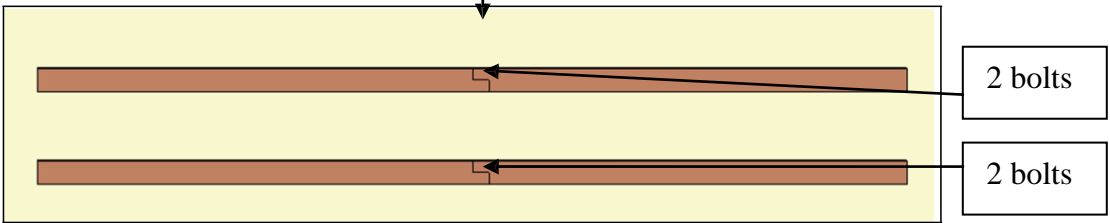

Step 5:
ASSEMBLE BASE OF THE ROOF: Attach the 2 roof timbers from step 4 to the remaining 2 longer roof timbers with 8 bolts (4 1/2"x 5/16") washers & nuts. (Match up the numbers to attach the two parts together). Tap the bolt all the way into the wood to set it. Then add a washer and nut and lightly tighten.

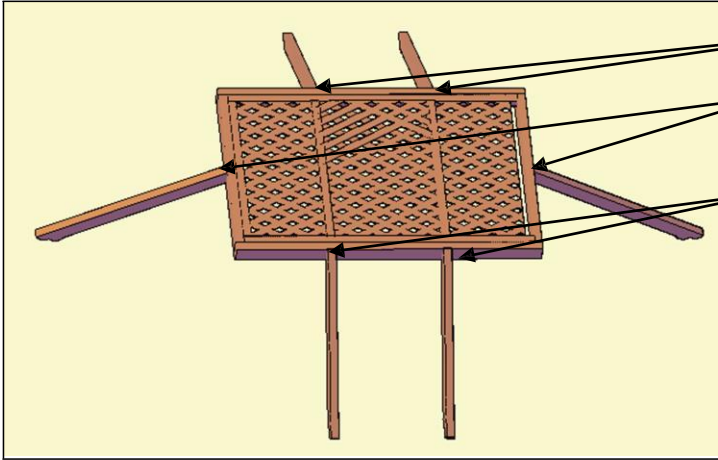

Step 6:

Attach 6 of the center rafters to the rooftop with 6 bolts (4" x 5/16") washers & nuts. One per rafter. (Match up the numbers to attach the two parts together). Tap the bolt all the way into the wood to set it. Then add a washer and nut and lightly tighten.

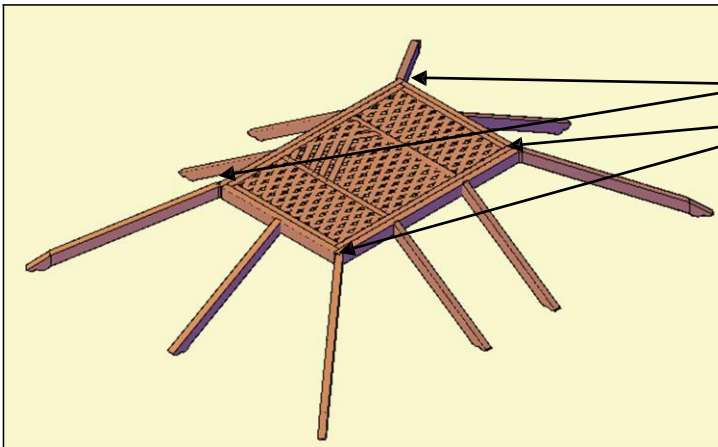

Step 7:

Attach the corner rafters to the rooftop with 4 bolts (8" x 3/8") washers & nuts. (Match up the numbers to attach the two parts together). Tap the bolt all the way into the wood to set it. Then add a washer and nut and lightly tighten.

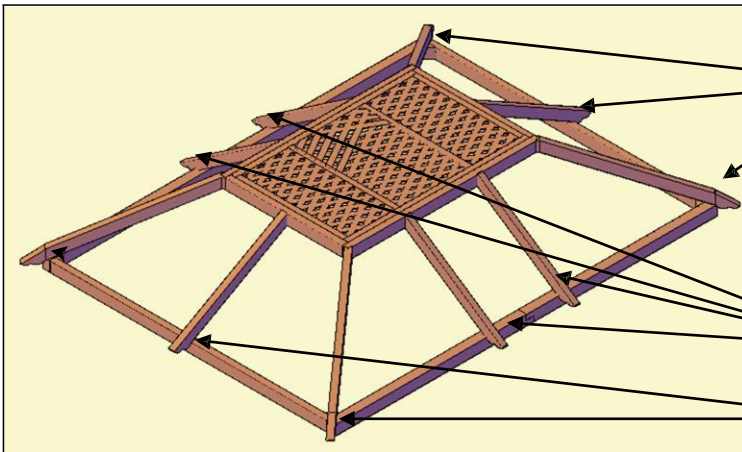

Step 8:

Attach the 10 rafters to base of roof with 10 bolts (6 1/2" x 3/8") washers & nuts. (Match up the numbers to attach the two parts together). Tap the bolt all the way into the wood to set it. Then add a washer and nut and lightly tighten.

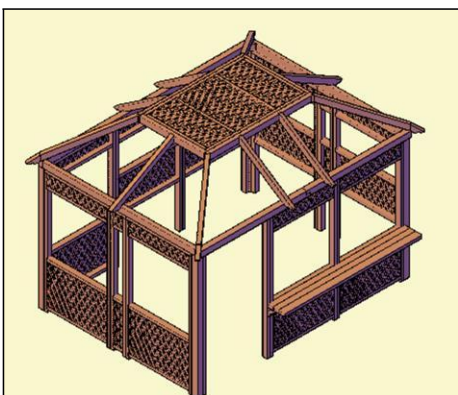

Step 9:

Lift the roof into place and attach to walls with 30 deck screws (3" x 8"). (Match up the numbers to attach the two parts together).

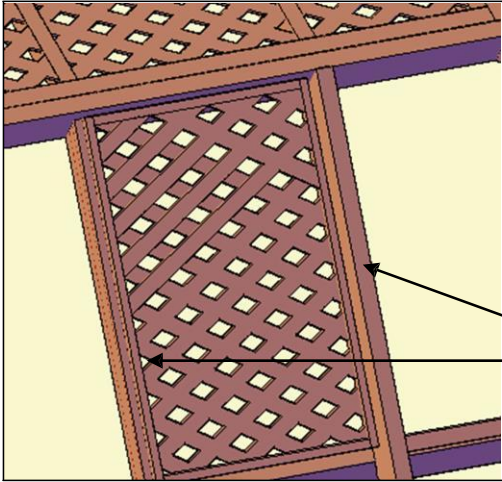

Step 10:

Attach the Roof panel to rafters with six deckscrews (3"x 5/16"). And repeat the process in all the panels.

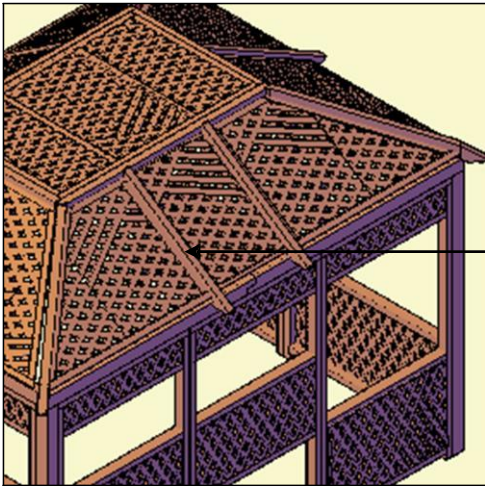

Step 11:

Attach the cover of rafters to roof panel with three deckscrews (3"x 8"). And repeat the process in all the panels of roof and fill between gaps with silicone.