









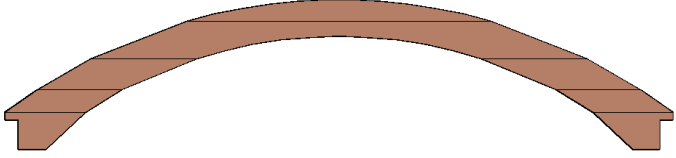

800-403-9259 (Toll Free)

Assembly Instructions for: **CUSTOM ARCHED PERGOLA**

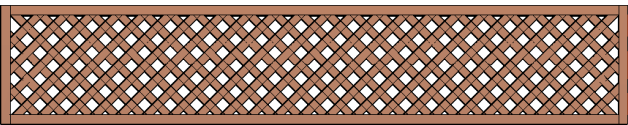
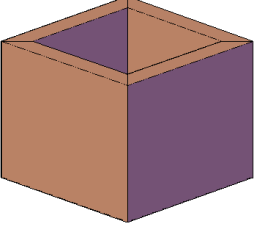
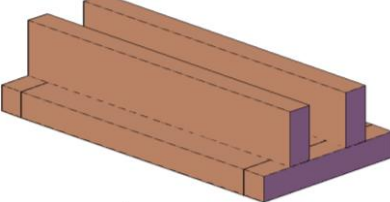

CONTENT OF THE BOXES

Quantity	Description	Drawing
4	Posts	
2	Supports (21'-3")	
2	Supports (16')	
10	Arched Rafters	
17	Roof Slats	
1	Roof support	
4	Small supports for Roof support	
4	Braces (48")	
4	Braces (46")	
16	Lattice Panels	
4	Trim pieces for bottom of posts	
1	Ceiling fan base	

ASSEMBLY INSTRUCTIONS

All Pergolas are completely erected in the shop prior to be crating for shipping. All hardware is included. All parts are fully sanded, routed, notched, drilled and numbered for ease of re-assembly. The parts that go together have the same numbers/letters written next to the predrilled holes they attach to.

All Pergola parts are notched into the part they connect to. You'll find the numbers next to the notches and/or drill holes. Before beginning re-assembly, place the parts that go together on the ground with one another so you don't have to be searching around in the middle of the re-assembly. Most pergolas take less than one day to reassemble with one helper. Very large pergolas (6 posts or larger) usually require a second day to finish up.

STEP 1:

Attach the four posts to concrete.

Anchor (9 15/16" x 9 15/16" opening - made with 1/4" thick steel)

Lag bolts

Wood trim to hide metal when finished

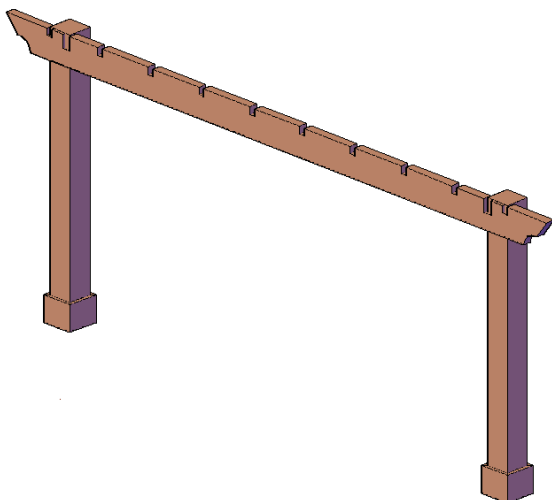
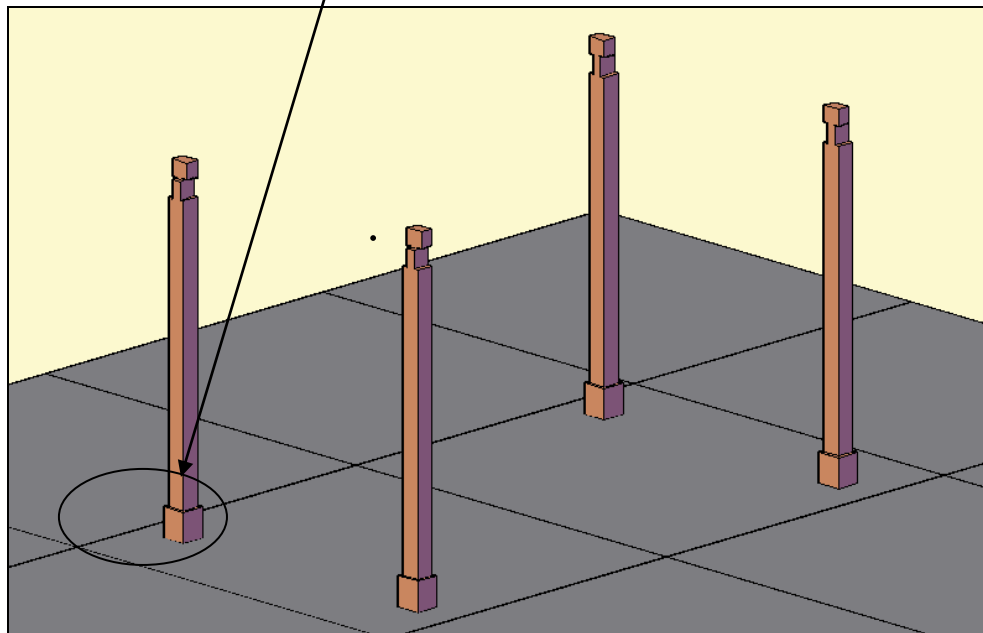
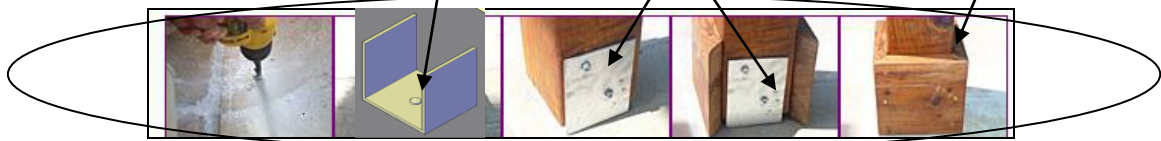

STEP 2:

Attach support to posts with four bolts (12" x 3/8") washers & nuts. (Match numbers). Tap the bolt all the way into the wood to set it, then add a washer and nut and lightly tighten.

Repeat this step with the other supports.

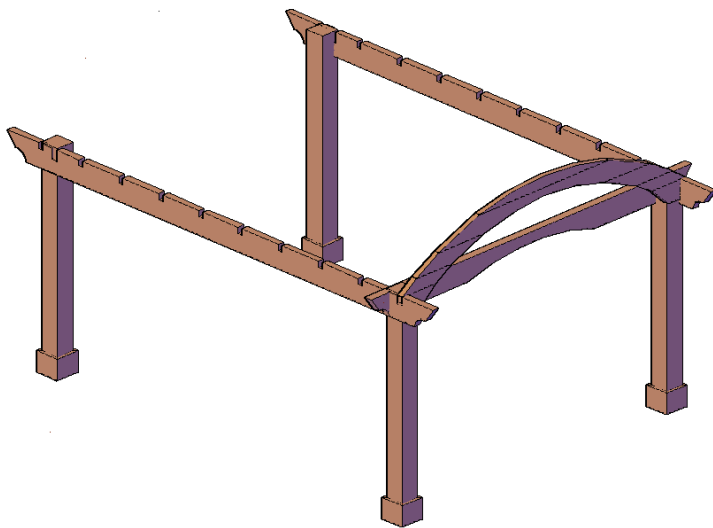

STEP 3:

Attach the arched rafter and support (16') to posts with two bolts per post (13" x 3/8") washers & nuts. (Match numbers). Tap the bolt all the way into the wood to set it, then add a washer and nut and lightly tighten.

Repeat this step in the other side (Arched Rafter, support and Posts).

STEP 4:

Attach brace (48") to post & arched rafter with two bolts, washers & nuts. (Match numbers). Tap the bolt all the way into the wood to set it, then add a washer and nut and lightly tighten.

Repeat this step with the other braces.

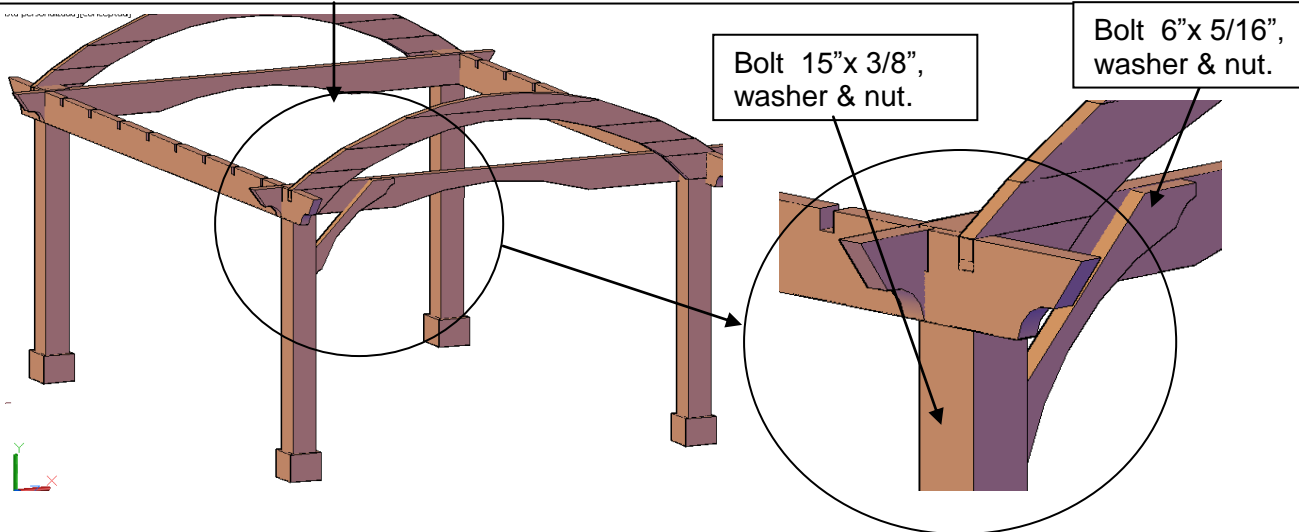

Bolt 15" x 3/8",
washer & nut.

Bolt 6" x 5/16",
washer & nut.

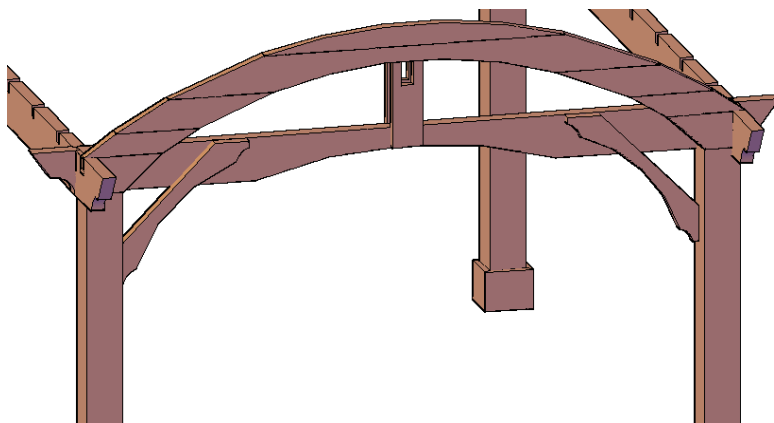

STEP 5:

Attach Small supports to support (16') with two bolts (9" x 3/8"), washers & nuts. (Match numbers). Tap the bolt all the way into the wood to set it, then add a washer and nut and lightly tighten.

Repeat this step with the other small supports.

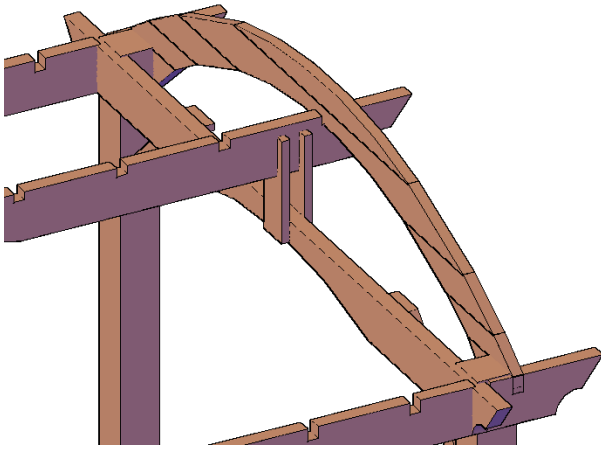

STEP 6:

Attach Roof support to the small supports with two bolts (7" x 3/8"), washers & nuts. (Match numbers). Tap the bolt all the way into the wood to set it, then add a washer and nut and lightly tighten.

Repeat this step with the other small supports.

STEP 7:

Attach the Ceiling fan base to Roof support with two bolts (7" x 3/8"), washers & nuts. (Match numbers). Tap the bolt all the way into the wood to set it, then add a washer and nut and lightly tighten.

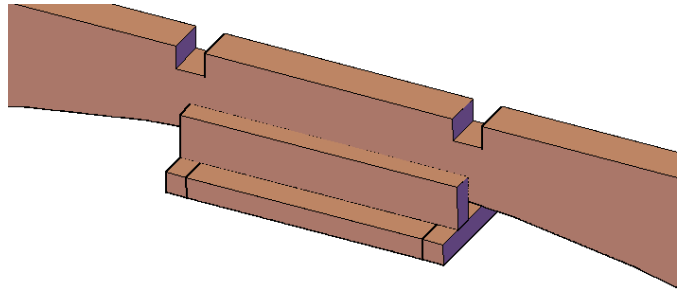

STEP 8:

Attach arched rafters to supports with galvanized deck screws (3"x 8") at 45 degree angles to attach to the supports. There are 8 screws used per rafter.

Make sure each rafter's notches are snugly into the supports before adding the deck screws. The supports have lines marking the exact spot to attach the rafter. Just make sure to stay to the markings on the supports to keep the spacing exactly the same (default rafter spacing is 18" on center unless custom ordered differently). Start at one end and attach one rafter at a time from both sides and on both ends before moving to the next rafter. *And repeat the process in all Arched Rafters.*

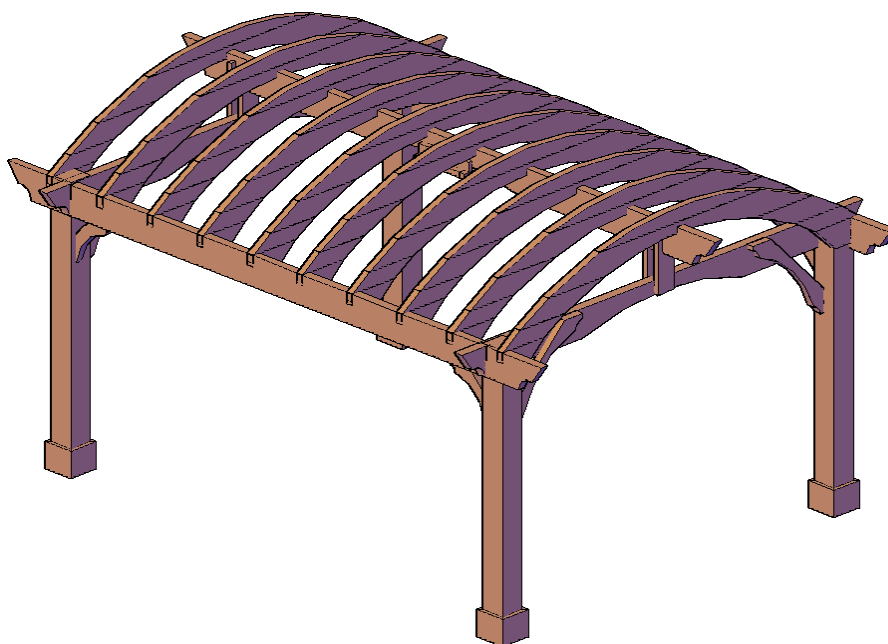

STEP 9:

Attach roof slats to arched rafters with deck screws (3"x 8").
And repeat the process in all roof slats.

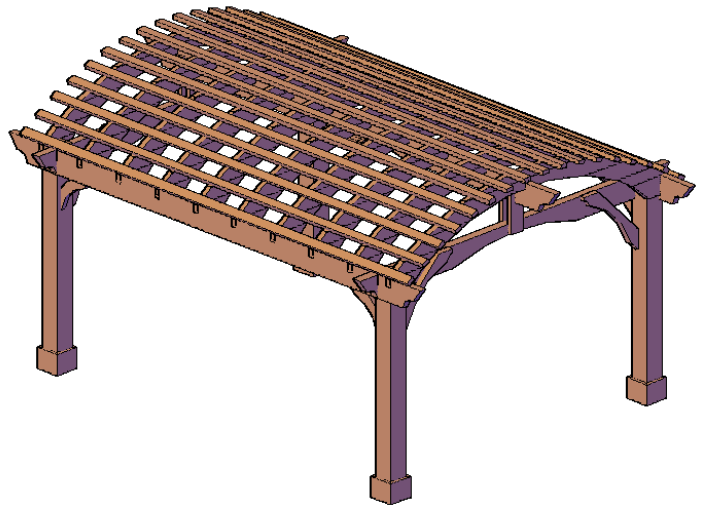

Step 10:

Place the lattice panels atop the roof slats. Then using the deck screws supplied, attach each lattice panel to both the roof slats and to the sides of the roof slats. A screw every 2 or 3 ft is sufficient.

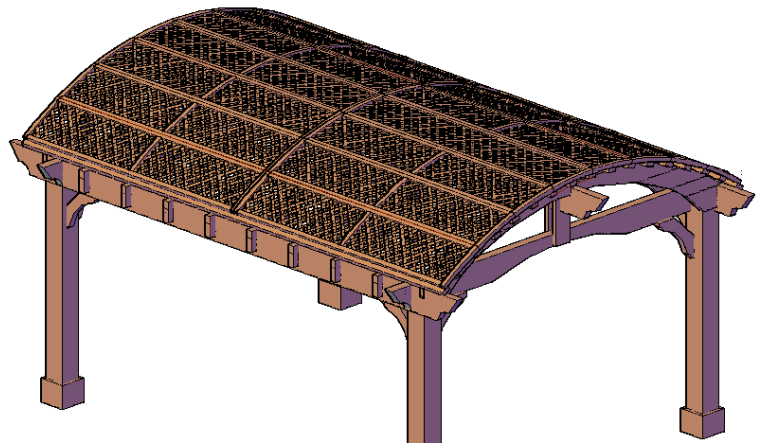
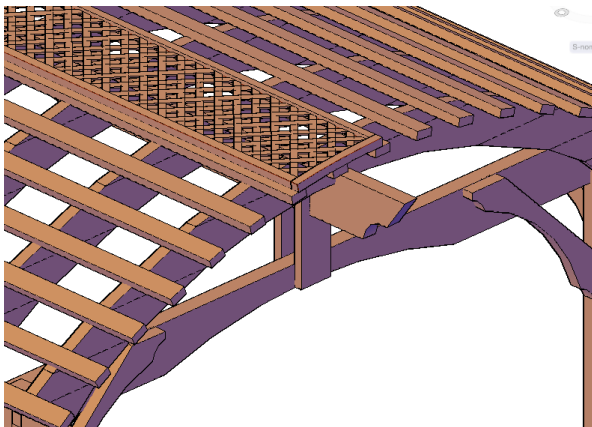

This completes the pergola assembly. Hope you enjoy your set for many decades. If you ever have a problem or a question, don't hesitate to call us (800-403-9259) or email us. We are here to support you.